

**southco**

PROPRIETARY ITEM - EXCEPT FOR USES EXPRESSLY GRANTED IN WRITING INFORMATION DISCLOSED HEREON IS CONFIDENTIAL AND ALL RIGHTS PATENT AND OTHERWISE ARE RESERVED BY SOUTHCO, INC.

E5 CAMS STAINLESS STEEL  
BENT UP POSITION

DATE	DRAWN	CHKD	SCALE
21JUN2007	MJS		1:1

DRAWING NUMBER
J-E5-80-B

REV	DATE	DRAWN/CHKD	DESCRIPTION	PART NUMBER	MATERIAL	FINISH
				E5-80YY	STAINLESS STEEL	PASSIVATED
				E5-90YY	STAINLESS STEEL	ELECTROPOLISHED

**MILLIMETERS**

ALL DIMENSIONS WITHOUT TOLERANCES ARE FOR REFERENCE ONLY.

THIRD ANGLE PROJECTION

A3 PAPER SIZE

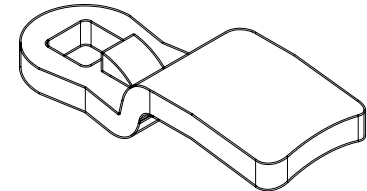
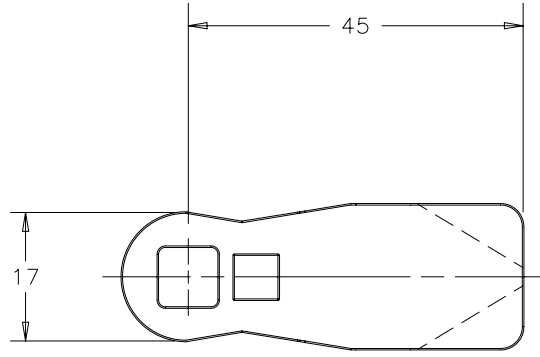

E5-XX06 SHOWN

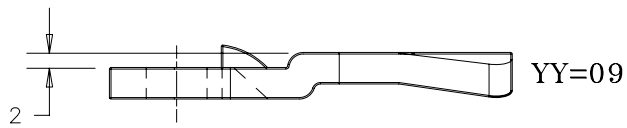
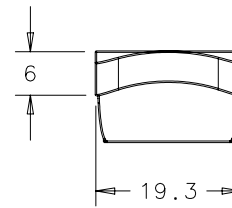
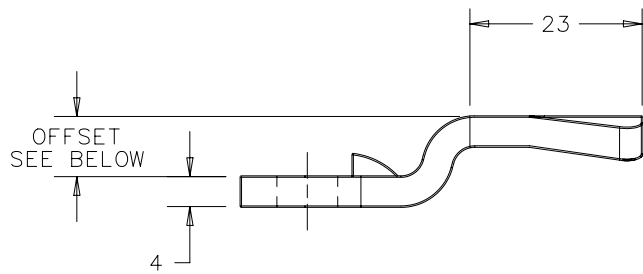

PART NUMBER: E5-XX09

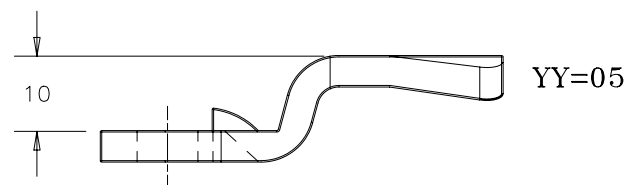

PART NUMBER: E5-XX05

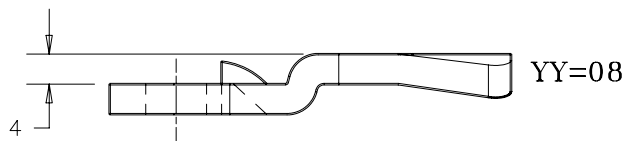

PART NUMBER: E5-XX08

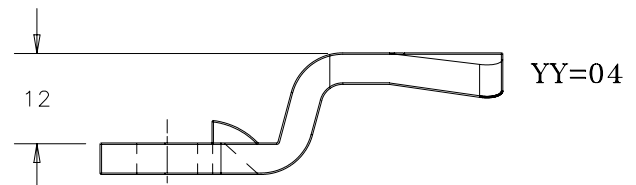

PART NUMBER: E5-XX04

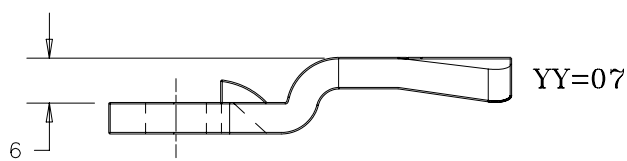

PART NUMBER: E5-XX07

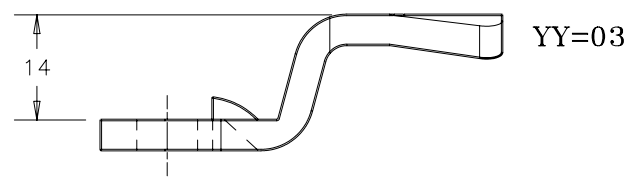

PART NUMBER: E5-XX03

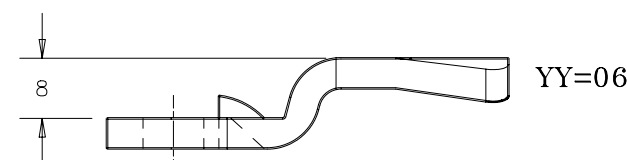

PART NUMBER: E5-XX06