

# AC Cable Splitter

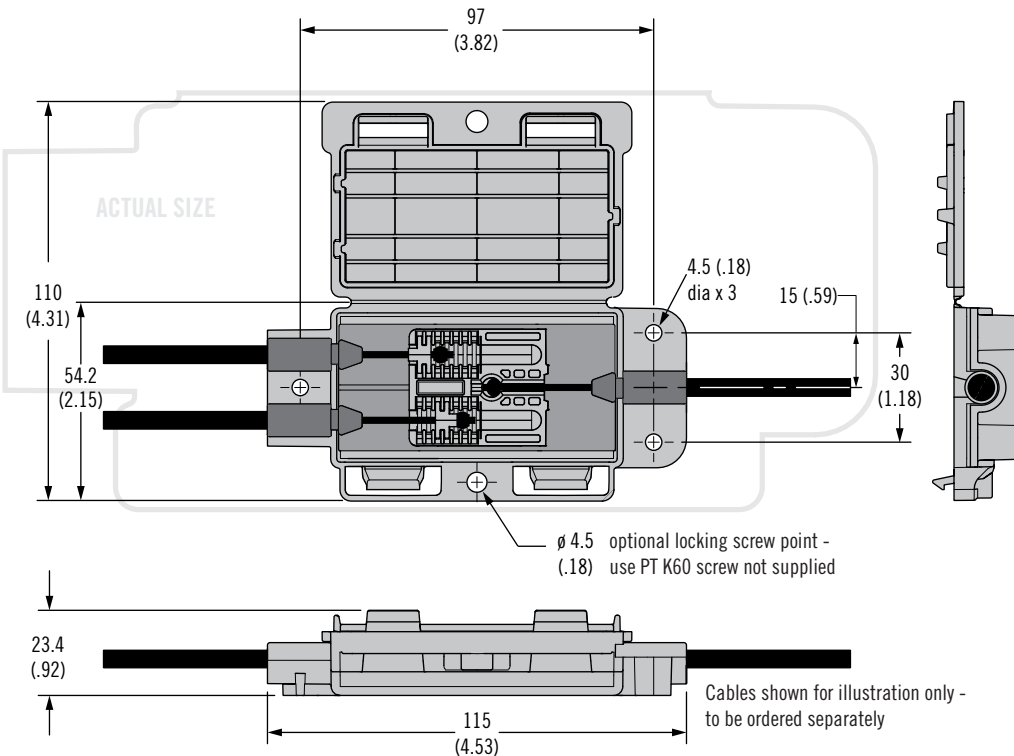

- Allows one actuation point for two rotary latches or two actuation points for one rotary latch
- Adjustable to fine tune timing of actuation points
- Cable splitter and cables sold separately

**Material and Finish**

Housing: Black Polypropylene  
Slider: Black Glass-filled nylon

**Notes**

For cable configuration, see Cable Selection Tool on Southco.com

**Packaged Delivery Condition**

**After customer assembly**

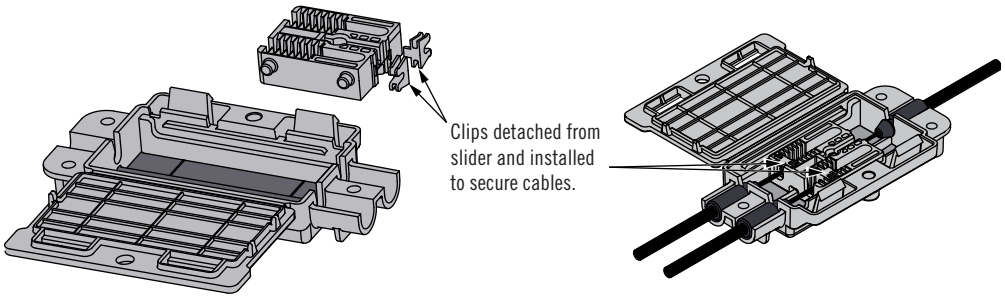

**One actuation point for two rotary latches**

**Two actuation points for one rotary latch**

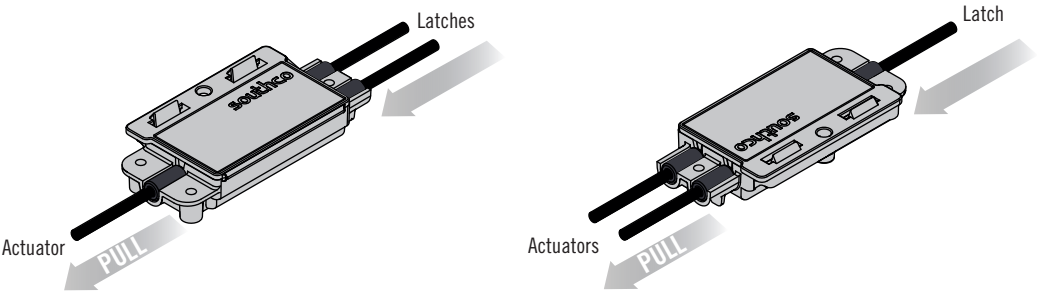

Part Number
AC-05-301-11

# AC Rotary Latch Cables

## Cable Assembly

- Connecting actuators with rotary latches
- Standard offering of cable assemblies

### Material and Finish

Cable: Stainless steel

Liner: Acetal

Jacket: Polypropylene

### Cable Assembly Part Number Selection

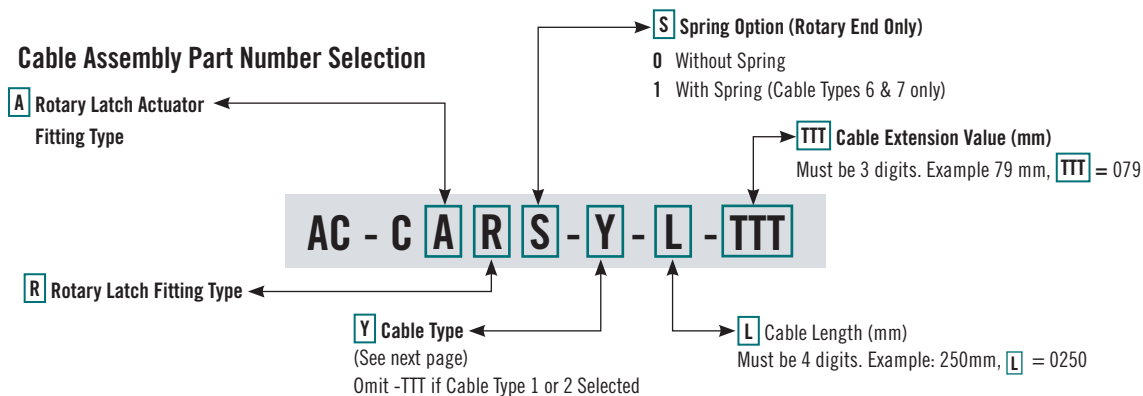

Fitting Type													
Barrel Fitting		L Fitting		Z Fitting		Eyelet Fitting		Ball Fitting		Threaded Fitting		Bare Cable	
<b>A &amp; R</b>	Material	<b>A &amp; R</b>	Material	<b>A &amp; R</b>	Material	<b>A &amp; R</b>	Material	<b>A &amp; R</b>	Material	<b>A &amp; R</b>	Material	<b>A &amp; R</b>	Material
A	Die-Cast	B	Plated Steel	C	Plated Steel	D	Stainless Steel	H	Stainless Steel	E	Steel, M4	0	Stainless Steel
J	Stainless Steel	K	Stainless Steel							F	Steel, 8-32		

### Straight Line of Sight

When cable is routing in a direct pull line between the actuator and the rotary latch with NO bends or concerns for accidental opening.

CABLE TYPE 1 - Bare Cable



CABLE TYPE 2 - Coated Cable for Appearance

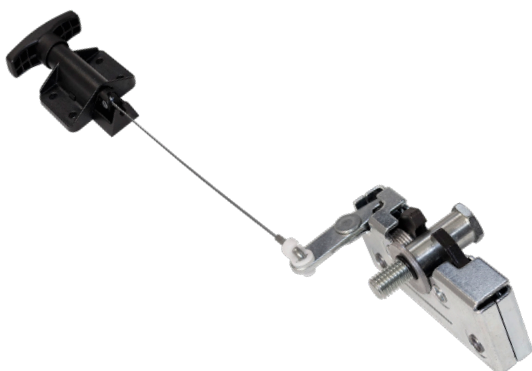

### Protected Cable Routing

Use when cable routing requires bending, cable management brackets or spring assist. Provides protection from accidental opening and for routing through bulk heads. For most applications the minimum bend radius is 50.8 mm (2 inches).



### For use with Mechanical Latches

CABLE TYPE 6 - Jacketed Cable with Snub End Coupling and Threaded Retainer

- Snub end mounts to all Southco actuators and mounting brackets
- Threaded end offers adjustable conduit mounting on latch end



CABLE TYPE 7 - Jacketed Cable with Snub and Conical End Couplings

- Snub end mounts to all Southco actuators and mounting brackets
- Conical end mounts to Rotary with integrated bracket or separate mounting bracket



### For use with R4-EM Latches

CABLE TYPE 4 - Jacketed Cable with Threaded and Snap Ring Retainer

- Threaded end offers adjustable conduit mounting on actuator end
- Snap ring retainer for connection to R4-EM electronic latches



CABLE TYPE 5 - Jacketed Cable with Conical End Coupling and Snap Ring Retainer

- Conical end mounts to most Southco actuators or separate mounting bracket
- Snap ring retainer for connection to R4-EM electronic latches





### Retainer Clip

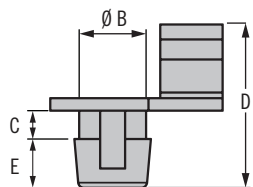

Round hole trigger / lever

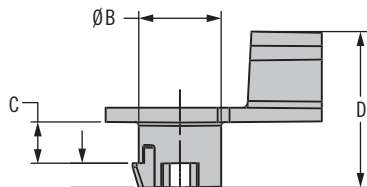

Slotted hole trigger / lever  
(R4-0-72894-X)

- For use with  $\varnothing 4$  (.157) rod or Southco cable assembly

### Material and Finish

Clip: Acetal

Bracket: Steel

### Part Number

See table

Latch Series	Trigger / Lever Type	Part Number	Colour	B	C	D	E	Trigger / Lever Cable Clip Hole Diameter or Slot Width	Trigger / Lever Thickness
R4-05	Bottom	R4-0-60784	Beige	5.9 (.23)	3.5 (.13)	16.4 (.65)	2.8 (.11)	6.4 (.25)	3 (.12)
R4-10	Perpendicular In-line Two Point	R4-0-43922	Black	5.9 (.23)	2.5 (.10)	14.4 (.57)	4.3 (.17)	6.3 (.25)	2 (.08)
		R4-0-43922-3	Red						
	Bottom / Top	R4-0-43922-2	Black	5.9 (.23)	4.5 (.18)	16.4 (.65)	4.3 (.17)	6.3 (.25)	4 (.16)
	Dual Trigger	R4-0-43922	Black	5.9 (.23)	2.5 (.10)	14.4 (.57)	4.3 (.17)	6.3 (.25)	2 (.08)
R4-0-43922-3		Red							
	R4-0-43922-2	Black	5.9 (.23)	4.5 (.18)	16.4 (.65)	4.3 (.17)	6.3 (.25)	4 (.16)	
R4-25	Bottom	R4-0-72894-4	Black	6.1 (.24)	4.5 (.18)	13 (.51)	N/A	6.3 (.25)	4 (.16)
R4-30	Perpendicular Two Point	R4-0-43922	Black	5.9 (.23)	2.5 (.10)	14.4 (.57)	4.3 (.17)	6.3 (.25)	2 (.08)
		R4-0-43922-3	Red						
	Bottom	R4-0-43922-2	Black	5.9 (.23)	4.5 (.18)	16.4 (.65)	4.3 (.17)	6.3 (.25)	4 (.16)
R4-20	Bottom	R4-0-43922-1	White	6.3 (.25)	4.5 (.18)	16.4 (.65)	4.3 (.17)	6.7 (.26)	4 (.16)
R4-50	Perpendicular								
R4-75	In-line	AC-9BX-20-34	Black	7.7 (.30)	2.9 (.11)	14.7 (.58)	3.3 (.13)	8.0 (.31)	2.7 (.11)

### Cable Mounting Bracket

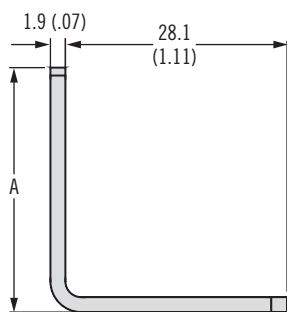

Part Number	A
R4-0-50253-1	31 (1.22)
R4-0-50253-2	28 (1.10)
R4-0-50253-3	19 (.75)

