



CM Cam Locks

Selection

- Removable core options provide maximum flexibility
- Fixed core options provide simple, economic solutions
- Sealed housings are available
- Multiple finishes
- A broad selection of lock housing and cam sizes available

Notes

All CM Cam Lock housings, cams, and lock core components can be ordered separately for maximum configuration flexibility with minimal inventory investment.

To determine the perfect CM Cam Lock components for your needs, simply follow the **Selection Guide** on the next page.

Cam Lock Options

Removable Core

- ⇒ Multiple key codes
- ⇒ Tool actuation
- ⇒ Change key codes in future
- ⇒ Configure to order



Non Sealed CM-6
Page 196



Sealed CM-3
Page 196

Key Options

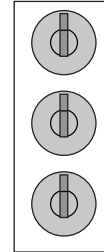

Keyed alike

Keyed differently

Master keyed, keyed differently

Tool Options

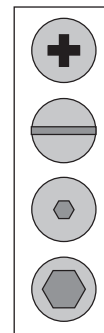

Phillips recess

Slotted

4mm Hex recess

8mm Hex recess

Fixed Core

- ⇒ Single key code
- ⇒ Key-locking
- ⇒ Wing driver
- ⇒ Integrated housing and lock core



Non Sealed CM-5
Page 197



Sealed CM-2
Page 197



Wing Driver CM-1
Page 198



Cam Lock Selection Guide

1. Once you have determined the **CM Cam Lock** version that best meets your needs, calculate the **Cam Grip** for your application using the illustration below.

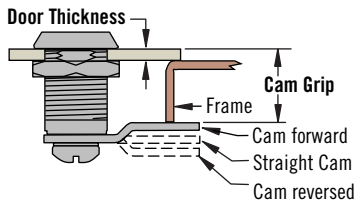

Notes: add 0.5 (.02) to your grip when using a sealed product.

2. In the **TAN** section below, locate the **Cam Grip** calculated for your application. If your grip falls between two values, use the higher value.

Notes: Certain grip values repeat in the table below. Use the value that results in the shortest housing possible based on the **Max. Door Thickness** allowed.

3. From this value, move right horizontally into the **GRAY** section and verify your door thickness falls within the **Max. Door Thickness** listed. Once this is verified, the housing length is selected and is illustrated by the **Housing Length Number**.

4. Returning to your original grip value in the **TAN** section, move down vertically into the **GREEN** section. The **GREEN** section illustrates the cams that are appropriate for your grip.

5. By determining the required cam orientation and length in the **BLUE** section, the appropriate **Cam Part Number** for your application is selected.

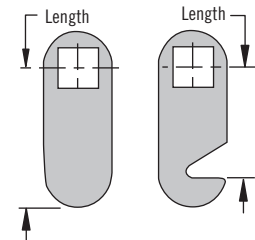

6. Proceed to the Cam Lock sections (CM-6, CM-3, CM-2, CM-5, and CM-1) to complete your **Part Number** selection.

Selection Guide

Cam Grips							Max. Door Thickness	Housing Length Number
20.7 (.81)	17.5 (.69)	14.3 (.56)	11.1 (.44)	8 (.31)	4.8 (.19)	1.6 (.06)	2.4 (.09)	7
25.4 (1.00)	22.2 (.88)	19.1 (.75)	15.9 (.63)	12.7 (.50)	9.5 (.38)	6.4 (.25)	7.1 (.28)	1
31.8 (1.25)	28.6 (1.13)	25.4 (1.00)	22.2 (.88)	19.1 (.75)	15.9 (.63)	12.7 (.50)	13.5 (.53)	2
38.1 (1.50)	34.9 (1.38)	31.8 (1.25)	28.6 (1.13)	25.4 (1.00)	22.2 (.88)	19.1 (.75)	19.8 (.78)	6
44.5 (1.75)	41.3 (1.63)	38.1 (1.50)	34.9 (1.38)	31.8 (1.25)	28.6 (1.13)	25.4 (1.00)	26.2 (1.03)	3
50.8 (2.00)	47.6 (1.88)	44.5 (1.75)	41.3 (1.63)	38.1 (1.50)	34.9 (1.38)	31.8 (1.25)	32.5 (1.28)	4
57.2 (2.25)	54 (2.13)	50.8 (2.00)	47.6 (1.88)	44.5 (1.75)	41.3 (1.63)	38.1 (1.50)	38.9 (1.53)	5
Cam Part Number							Cam Length	Cam Orientation
Cam Reversed		Straight		Cam Forward				
CM-C606	CM-C406	CM-C206	CM-C006	CM-C206	CM-C406	CM-C606	19.1 (.75)	No Hook
CM-C610	CM-C410	CM-C210	CM-C010	CM-C210	CM-C410	CM-C610	31.8 (1.25)	
CM-C614	CM-C414	CM-C214	CM-C014	CM-C214	CM-C414	CM-C614	44.5 (1.75)	
CM-L606	CM-L406	CM-L206	CM-H006	CM-H206	CM-H406	CM-H606	19.1 (.75)	Left
CM-L610	CM-L410	CM-L210	CM-H010	CM-H210	CM-H410	CM-H610	31.8 (1.25)	
CM-L614	CM-L414	CM-L214	CM-H014	CM-H214	CM-H414	CM-H614	44.5 (1.75)	
CM-H606	CM-H406	CM-H206	CM-H006	CM-L206	CM-L406	CM-L606	19.1 (.75)	Right
CM-H610	CM-H410	CM-H210	CM-H010	CM-L210	CM-L410	CM-L610	31.8 (1.25)	
CM-H614	CM-H414	CM-H214	CM-H014	CM-L214	CM-L414	CM-L614	44.5 (1.75)	

Also use the online configurator at www.southco.com



CM Cam Locks

Removable core

- Ideal for applications requiring multiple key codes or tool actuated options
- Sealed version meets NEMA 4 and IP65 water intrusion standards
- Lock cores and cams sold separately
- Master and non-master key codes available

Material and Finish

Housing: Zinc alloy, chrome plated or black powder coated
 Scalp: stainless steel

Performance Details

Average ultimate load on cam:
 180 N (40 lbf)

Installation Notes

See page 199

Accessories

See page 201

Part Number Selection

See table

Housing part number
 (no lock core or cam)

Order housing, lock core and cam separately

Lock core part numbers and installation see page 191

Cam page 199

To select cam part number see grip table page 195

Sealed Disc Tumbler

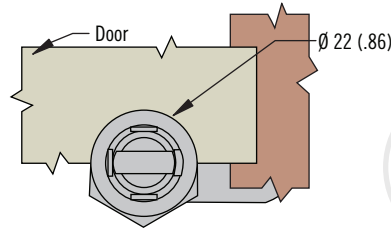

Non-Sealed Disc Tumbler

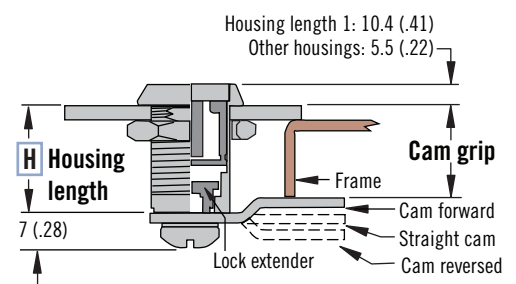
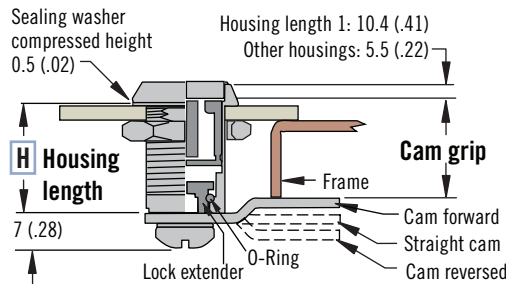
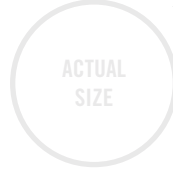
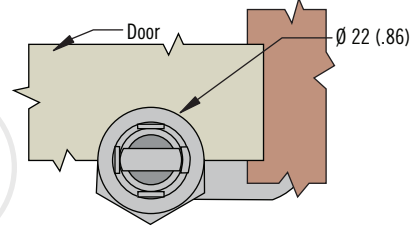

Cam Rotation

R 01 (Clockwise to Lock)

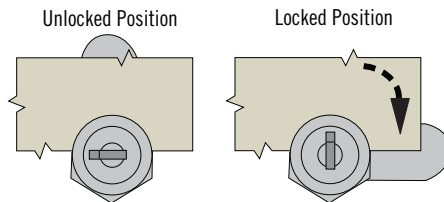

R 09 (Counter-Clockwise to Lock)

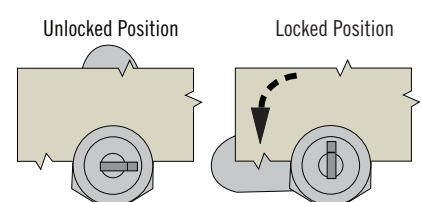

Sealed Version

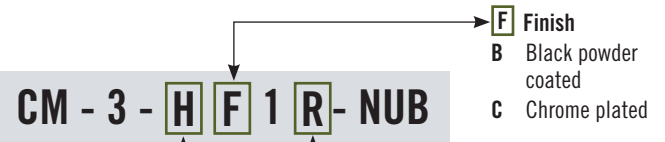

Max. Door Thickness	Housing Length	H Housing Length Number
7.1 (.28)	16 (.625)	1
13.5 (.53)	22 (.875)	2
19.8 (.78)	28.5 (1.125)	6
26.2 (1.03)	35 (1.375)	3
32.5 (1.28)	41 (1.625)	4
38.9 (1.53)	48 (1.875)	5

Non-sealed version



R Rotation
01 Clockwise
09 Counter-clockwise

CM Cam Locks

Fixed core



Sealed Disc Tumbler

Pictured with Lockcore Installed

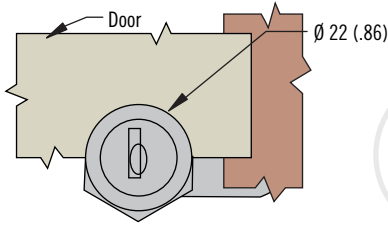

Non-Sealed Disc Tumbler

Pictured with Lockcore Installed

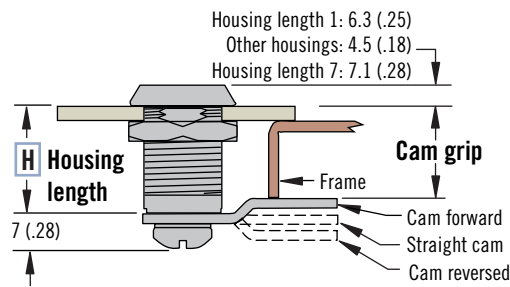
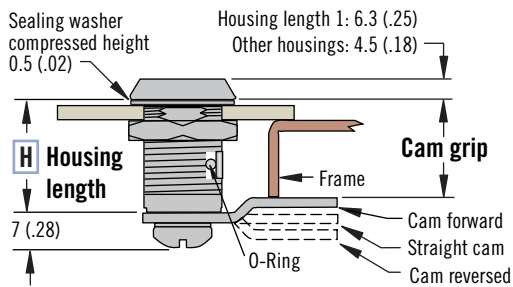
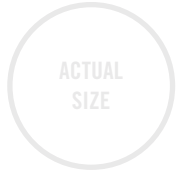
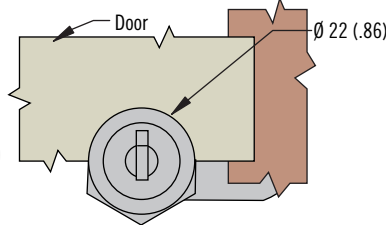

Cam Rotation

R 01 (Clockwise to Lock)

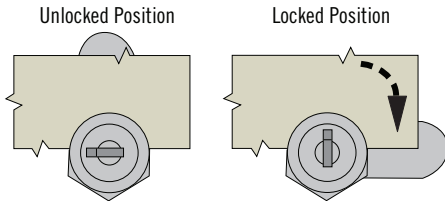

R 09 (Counter-Clockwise to Lock)

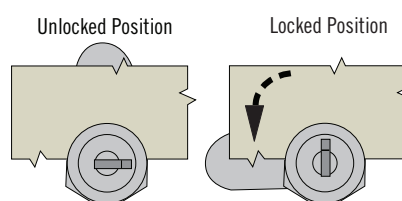

Sealed Version

Max. Door Thickness	Housing Length	H Housing Length Number
2.4 (.09)	11 (.438)	7 Non-Sealed Only
7.1 (.28)	16 (.625)	1
13.5 (.53)	22 (.875)	2
19.8 (.78)	28.5 (1.125)	6
26.2 (1.03)	35 (1.375)	3
32.5 (1.28)	41 (1.625)	4
38.9 (1.53)	48 (1.875)	5

Non-sealed version

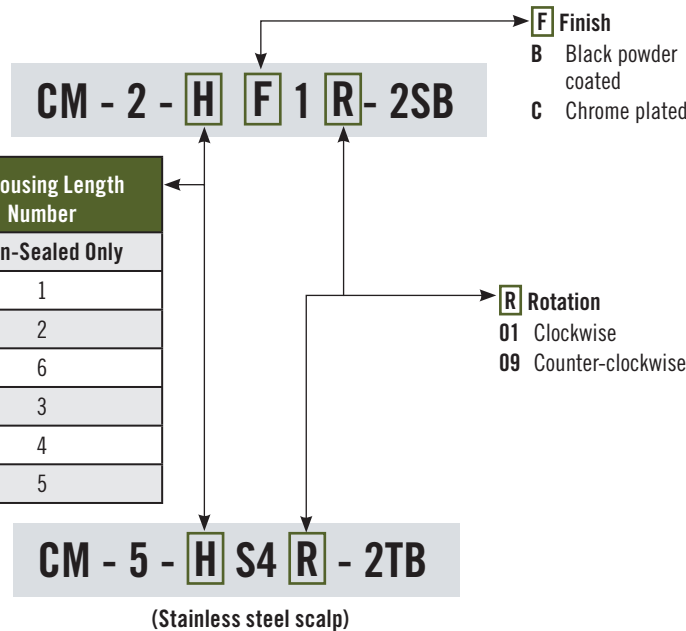

- Stainless steel scalp on housing and lock core on non-shuttered style
- Sealed version meets NEMA 4 and IP65 water intrusion standards
- Cams sold separately

Material and Finish

Housing: Zinc alloy, chrome plated or black powder coated
 Scalp: stainless steel

Performance Details

Average ultimate load on cam:
 180 N (40 lbf)

Installation Notes

See page 199

Accessories

See pages 169

Notes

Lock: Key code CH751, keyed alike, key removal in locked and unlocked positions (two keys supplied)

Part Number Selection

See table

Lock part number (no cam)

Order lock and cam separately

Cam page 199

To select cam part number see grip table page 195

Notes

CM-2-1 version is sealed but does not meet the NEMA 4 / IP65 standards



CM Cam Locks

Fixed core wing driver

- Sealed to meet NEMA 4 and IP65 water intrusion standards
- Smooth, consistent operation
- Cams sold separately

Material and Finish

Housing: Zinc alloy, chrome plated or black powder coated

Performance Details

Average ultimate load on cam: 180 N (40 lbf)

Installation Notes

See page 199

Accessories

See page 201

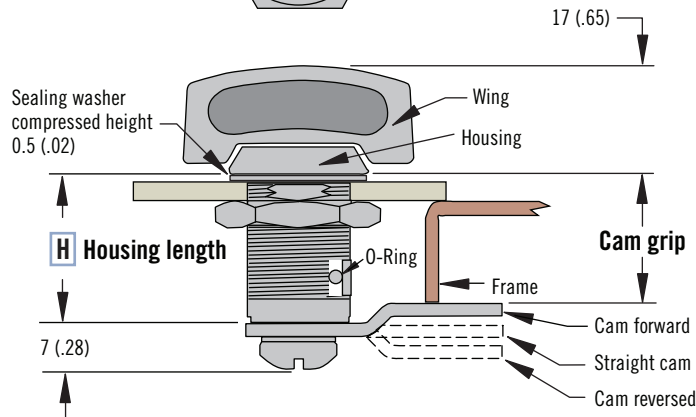
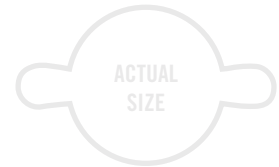
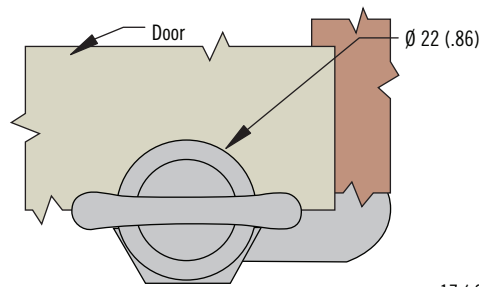

Cam Rotation

R 01 (Clockwise to Lock)

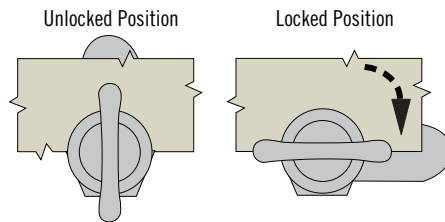

R 09 (Counter-Clockwise to Lock)

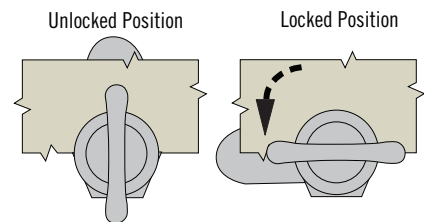

Part Number Selection

See table

Lock part number (no cam)

Order lock and cam separately

Cam page 199

To select cam part number see grip table page 195

F Housing Finish
B Black powder coated
C Chrome plated

R Rotation
01 Clockwise
09 Counter-clockwise

W Wing Finish
B Black powder coated
C Chrome plated

CM - 1 - H F 1 R - 1 W

H Housing Length Number	Housing Length	Max. Door Thickness
1	16 (.625)	7.1 (.28)
2	22 (.875)	13.5 (.53)
3	35 (1.375)	26.2 (1.03)

CM Cam Locks

Cams & installation

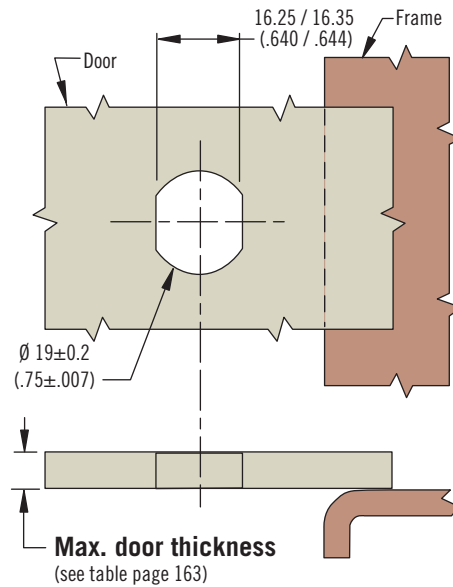
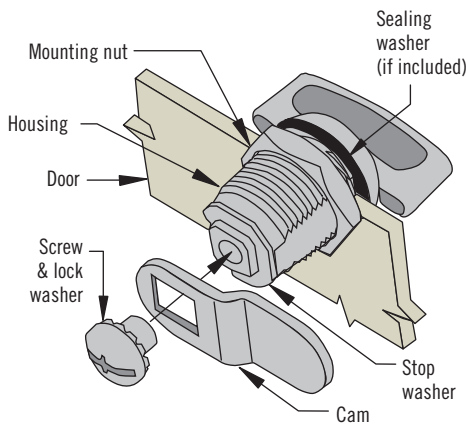

Installation Notes

1. Place sealing washer onto housing (if included) and put through the mounting hole (see panel preparation).
2. Install mounting nut and tighten to 5 N•m (44 in•lbf).
3. Install cam to assembly. Properly orientate for rotation and grip.
4. Install screw. Tighten to 4 N•m (35 in•lbf).

Material and Finish

Cam: Steel plated

Part Number Selection

See table
 Order lock and cam separately
 Cam part number (no lock)
 For Lock selection see pages 196-198

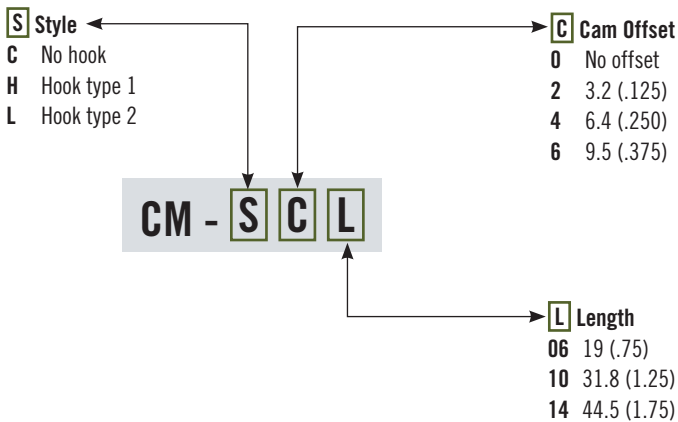
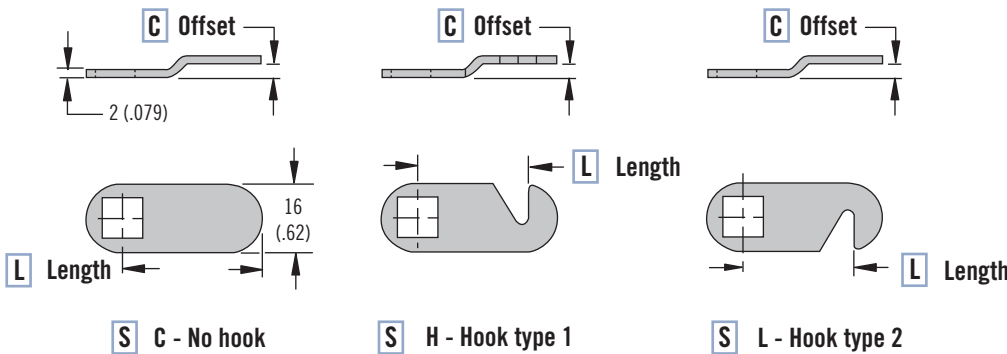
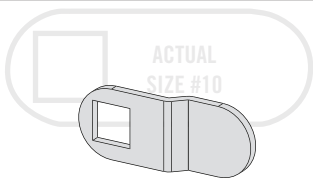



CM Mini Cam Locks

Fixed core

- Compact design
- Non-shuttered lock core
- Cams sold separately

Material and Finish

Lock: Zinc alloy, chrome plated or black powder coated
 Cam: Steel, zinc plated

Performance Details

Average ultimate load on cam:
 160 N (35 lbf)

Installation Notes

1. Install mounting nut and tighten to 4 N•m (35 in•lbf).
2. Install cam to assembly. Properly orientate for rotation and grip.
3. Install screw. Tighten to 4 N•m (35 in•lbf).

Accessories

See page 201

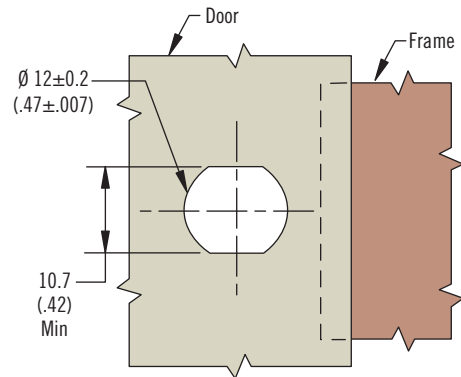
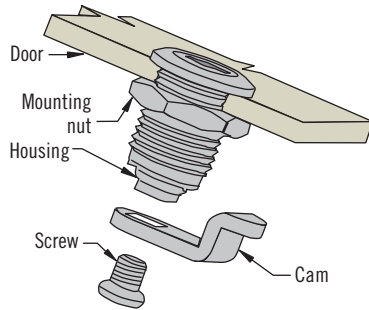
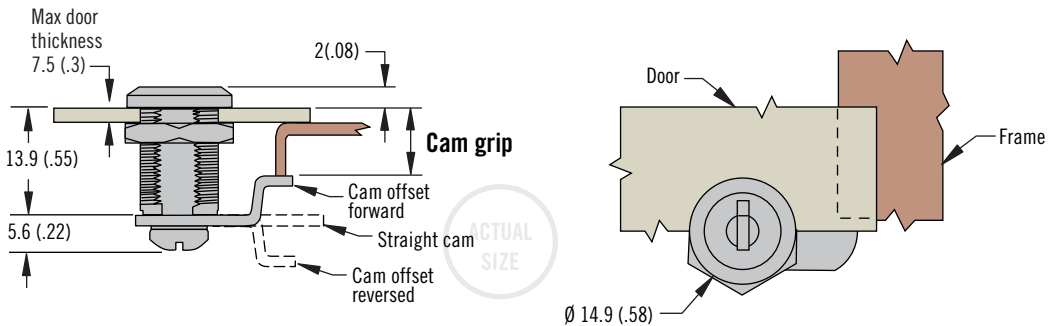

Cam - Offset

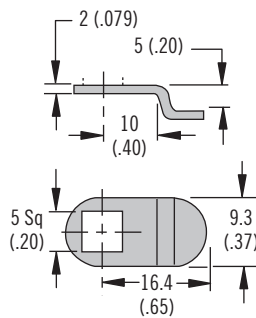

Cam - Straight

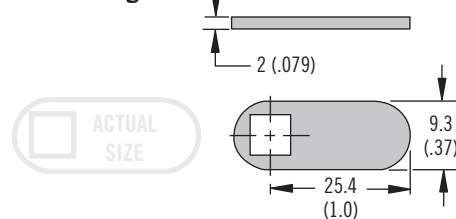

Cam Grip		
Cam Grip	Cam Type	Cam Part Number
9.7 (.38)	Offset forward	CM-M101
15.4 (.61)	Straight	CM-M002
21.3 (.84)	Offset reverse	CM-M101

Part Number Selection

Lock part number (no cam)

Order lock and cam separately

To select cam part number see grip table above

F Housing Finish ← Black powder coated (B), Chrome plated (C)
S Style → 12N Wing, 21B Key-locking
KC Key Code → Omit for wing style, KA Keyed alike M01 (2 keys supplied), KD Keyed differently (10 key codes provided in a non-master key system) M01 to M10 (2 keys supplied)

CM - 9 - 1 F 109 - S - KC

CM Cam Locks

Accessories · Keys · Spares



Accessories (Add adjustment value to door thickness when accessory is used)

Metal Dust Cover



Metal Pull Tab



Plastic Dust Cover



Trim Washer



Pull Tab - In-Line



Prong Washer



Pull Tab - Perpendicular



Sealing Washer



Overmolded Key



Plain Key



Item	Part Number	Material	Adjustment Value	Suitable for		
				CM	Mini CM	PT
Metal dust cover	CM-A-10-01	Zinc alloy, chrome plated and stainless steel	0.7 (.027)	✓		✓
Plastic dust cover	90-2	Santoprene, black	2.1 (.085)	✓		✓
Pull tab - In-line	CM-A-08-01	Nylon, black	2.1 (.085)	✓		✓
Pull tab - Perpendicular	CM-A-08-02	Nylon, black	2.1 (.085)	✓		✓
Metal pull tab	CM-A-09	Stainless steel	1.5 (.059)	✓		✓
Trim washer	CM-A-07-N	Steel, nickel plated	0.8 (.031)	✓		✓
Prong washer	CM-A-04	Steel, plated	0.9 (.035)	✓		✓
Sealing washer	CM-A-03	Rubber, black	1.0 (.039)	✓		✓

Keys (contact Southco for custom overmolded logo options)

Item	Part Number	Suitable for		
		CM	Mini CM	PT
Plain key CH751 pair	PK-10-01	✓		
Overmolded key CH751 pair	PK-10-01-05	✓		
Overmolded key CH751 single	PK-10-10-05	✓		
Control (removal) key single	PK-11-03	✓		
Master key single	PK-24-01	✓		
Plain key M01 pair	PK-10-01-M01		✓	
Tubular key T0001 pair	PK-60-01-T0001			✓

Replacement Parts

Item	Part Number	Material	Suitable for		
			CM	Mini CM	PT
Housing mounting nut	CM-A-01	Zinc alloy	✓		
Housing mounting nut	PT-A-04-01				✓
Housing mounting nut	CM-B-01			✓	
Housing mounting clip	CM-A-05	Spring steel, plated	✓		
Cam mounting screw	CM-A-02	Steel, plated	✓		
Cam mounting screw	CM-B-03			✓	
Tooth washer hex nut	CM-A-12		✓		
Lockwasher	PT-A-09				✓
Cam mounting nut	PT-A-05-01				✓