



ST-8P Hinge

Position control · Constant torque

- Designed for overmolding
- Brings constant torque performance to a wide range of applications
- Space efficient design provides high torque in minimum space
- Never requires adjustment

Material and Finish

Aluminum, plastic and hardened steel

Performance Details

Cycle performance:
20,000 cycles within $\pm 20\%$ of static torque specification

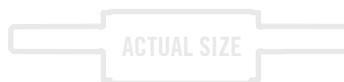
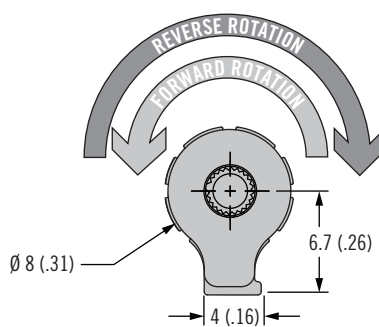
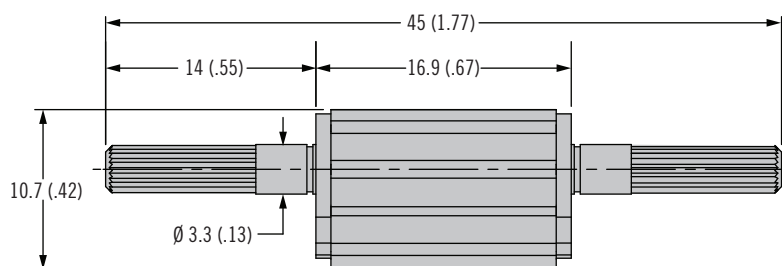

Part Number

See table

Symmetric Torque Versions	
Part Number	Static Torque (Forward and Reverse) N·m (in·lbf)
ST-8P-40SA-50	0.45 (4)
ST-8P-60SA-50	0.68 (6)
ST-8P-80SA-50	0.9 (8)

Asymmetric Torque Versions		
Part Number	Static Torque N·m (in·lbf)	
	Forward N·m (in·lbf)	Reverse N·m (in·lbf)
ST-8P-40FA-50	0.45 (4.0)	0.27 (2.4)
ST-8P-60FA-50	0.68 (6.0)	0.41 (3.6)
ST-8P-80FA-50	0.90 (8.0)	0.54 (4.8)
ST-8P-100FA-50	1.13 (10.0)	0.68 (6)
ST-8P-40RA-50	0.27 (2.4)	0.45 (4)
ST-8P-60RA-50	0.41 (3.6)	0.68 (6)
ST-8P-80RA-50	0.54 (4.8)	0.9 (8)
ST-8P-100RA-50	0.68 (6.0)	1.13 (10)

ST-11P2 Hinge

Position control · Constant torque

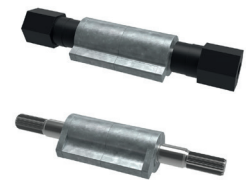

HEX SHAFT STYLE

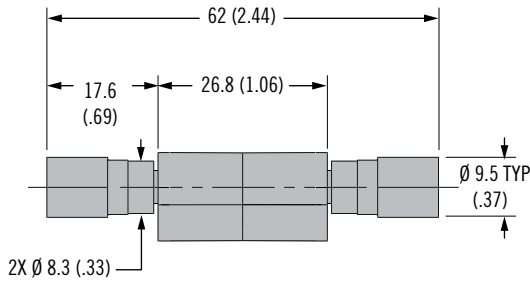

Ø 11
(.43)

Housing profile for symmetric torque.

Forward Torque Reverse Torque

Ø 11
(.43)

Housing profile for asymmetric torque.

KNURLED SHAFT STYLE

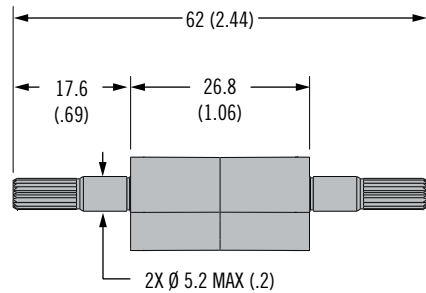

ACTUAL SIZE

Ø 11
(.43)

Housing profile for symmetric torque.

Forward Torque Reverse Torque

Ø 11
(.43)

Housing profile for asymmetric torque.

Symmetric Torque Versions		
Part Number	Shaft Style	Static Torque N·m (in·lbf)
ST-11P2-350SA-33	HEX	3.95 (35)
ST-11P2-300SA-33	KNURL	3.39 (30)
ST-11P2-250SA-33	KNURL	2.82 (25)
ST-11P2-200SA-33	KNURL	2.26 (20)
ST-11P2-150SA-33	KNURL	1.69 (15)

Asymmetric Torque Versions			
Part Number	Shaft Style	Forward Torque N·m (in·lbf)	Reverse Torque N·m (in·lbf)
ST-11P2-400FA-33	HEX	4.52 (40)	3.16 (28)
ST-11P2-350FA-33	HEX	3.95 (35)	2.77 (24.5)
ST-11P2-300FA-33	KNURL	3.39 (30)	2.37 (21)
ST-11P2-250FA-33	KNURL	2.82 (25)	1.98 (17.5)
ST-11P2-200FA-33	KNURL	2.26 (20)	1.58 (14)
ST-11P2-150FA-33	KNURL	1.69 (15)	1.19 (10.5)
ST-11P2-400RA-33	HEX	3.16 (28)	4.52 (40)
ST-11P2-350RA-33	HEX	2.77 (24.5)	3.95 (35)
ST-11P2-300RA-33	KNURL	2.37 (21)	3.39 (30)
ST-11P2-250RA-33	KNURL	1.98 (17.5)	2.82 (25)
ST-11P2-200RA-33	KNURL	1.58 (14)	2.26 (20)
ST-11P2-150RA-33	KNURL	1.19 (10.5)	1.69 (15)

- Designed for overmolding
- Brings constant torque performance to a wide range of applications
- Space efficient design provides high torque in minimum space
- Never requires adjustment

Material and Finish

Zinc alloy and hardened steel

Performance Details

Cycle performance:
20,000 cycles, see trade drawing for details

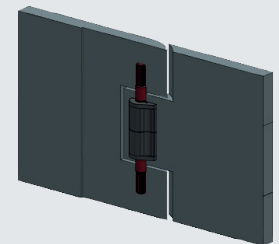

Part Number

See table