



TL Draw Latch

Over-center · Wire bail

- Compact latch
- Multiple link options for application variances

Material and Finish

Stainless steel or steel, zinc plated

Performance Details

Steel working load:

Compact heavy-duty:

1290 N (290 lbf)

Compact: 220 N (45 lbf)

Stainless steel working load:

Compact heavy-duty:

800 N (180 lbf)

Compact: 220 N (45 lbf)

Installation Notes

Install assembly with M4 (No. 6) round head screws (not supplied) or 4 (.156) rivets

Notes

Order keepers separately, see page 338

Exposed Mounting Holes

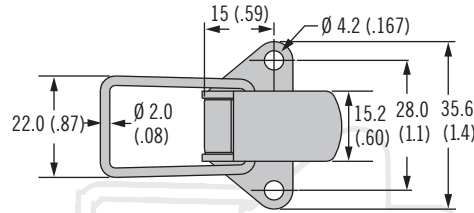

Heavy-Duty

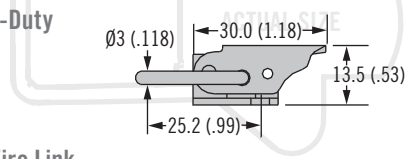

Flat Wire Link

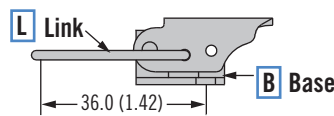

Short Curved Wire Link

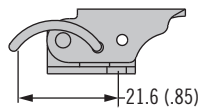

Long Curved Wire Link

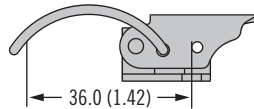

Shallow Hook Link

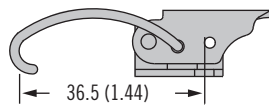

Deep Hook Link

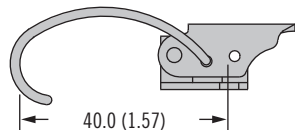

Concealed Mounting Holes

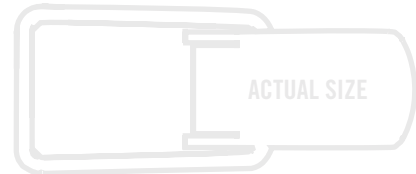
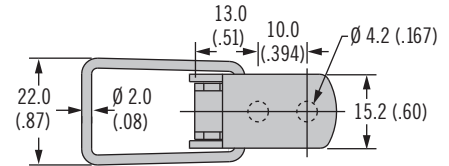

Flat Wire Link

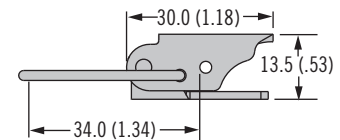

Short Curved Wire Link

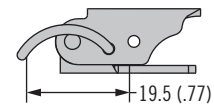

Long Curved Wire Link

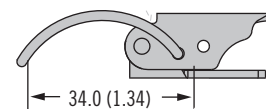

Shallow Hook Link

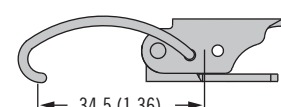

Deep Hook Link

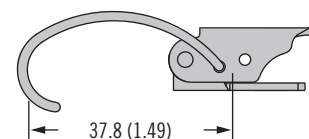

Part Number Selection

Latch only

See page 338 for keepers

L Link style

- 1 Flat
- 2 Short curved
- 3 Long curved
- 4 Shallow hook
- 5 Deep hook
- 6 Heavy-duty

F Finish

- 07 Steel, zinc plated
- 52 Stainless steel, passivated

TL - 20 - **B** 0 **L** - **F**

B Base type

- 1 Exposed
- 2 Concealed

TL Draw Latch

Over-center · Wire bail



Exposed Mounting Holes

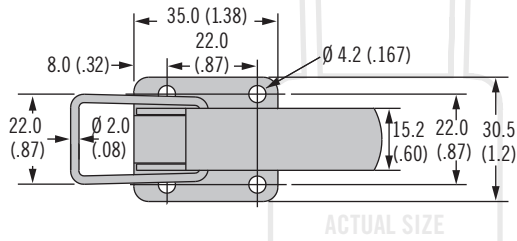

Concealed Mounting Holes

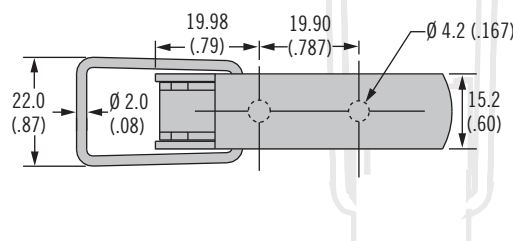

Flat Wire Link

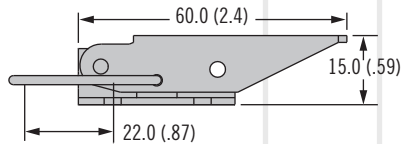

Flat Wire Link

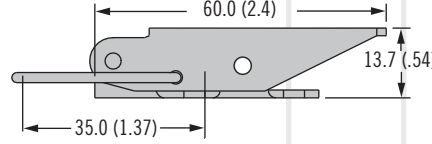

Curved Wire Link

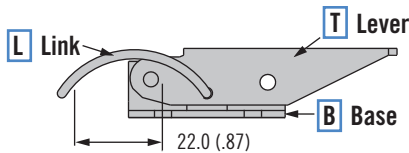

Curved Wire Link

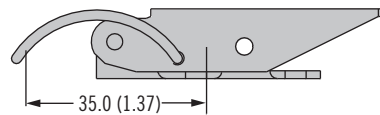

Shallow Hook Link

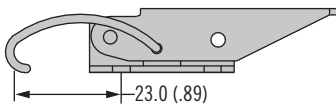

Shallow Hook Link

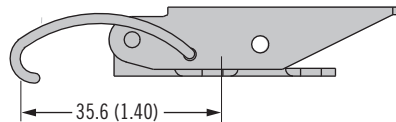

Deep Hook Link

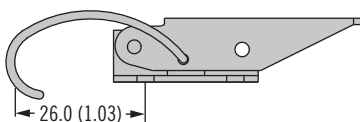

Deep Hook Link

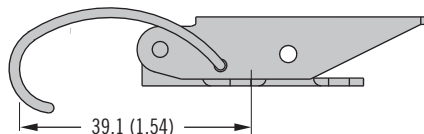

- Multiple link options for application variances
- Secondary locking style available

Material and Finish

Stainless steel or steel, zinc plated

Performance Details

Steel:

Working load: 220 N (45 lbf)

Stainless Steel:

Working load: 220 N (45 lbf)

Installation Notes

Install assembly with M4 (No. 6) round head screws (not supplied) or 4 (.156) rivets

Notes

Order keepers separately, see page 338

L Link style

- 1 Flat
- 3 Short curved
- 4 Shallow hook
- 5 Deep hook

F Finish

- 07 Steel, zinc plated
- 52 Stainless steel, passivated

TL - 40 - B T L - F

B Base type

- 1 Exposed
- 2 Concealed

T Lever type

- 0 Standard
- 1 Secondary catch (Exposed base only)
- 2 Padlockable (Steel model only) (Concealed base only)

Part Number Selection

Latch only

See page 338 for keepers



TL Keeper

Keeper

- Multiple keeper options for application variances
- Suitable for all TL-20 and TL-40 latches

Material and Finish

Stainless steel, steel, zinc plated

Installation Notes

Install assembly with M4 (No. 6) round head screws (not supplied) or 4 (.156) rivets

Exposed

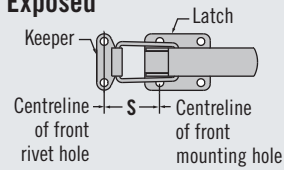

Concealed

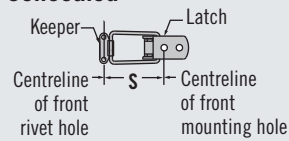

Part Number Selection

1. Select your latch choice in the draw latch column
2. Select your keeper style in the keeper style row
3. Where the column and row meet use the figure for your install S dimension

Small

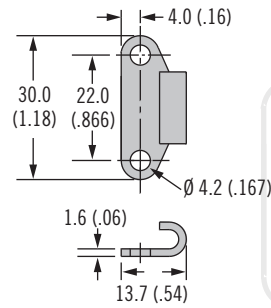

Narrow

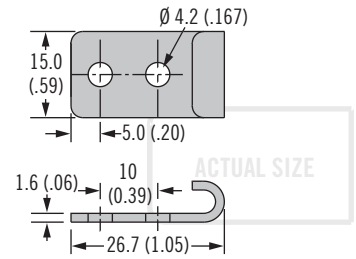

Right Angle

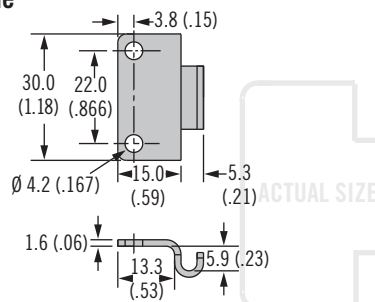

Large

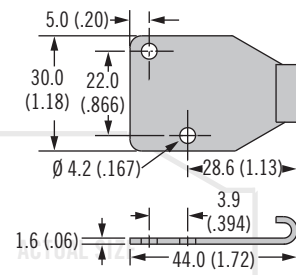

Medium

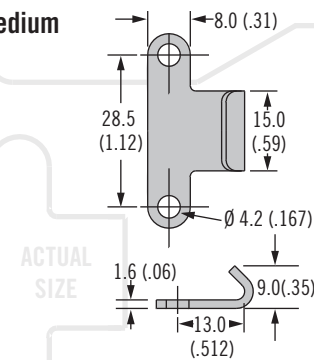

- B** Base type
- 1 Small
 - 2 Narrow
 - 3 Right angle
 - 5 Large
 - 9 Medium

- F** Finish
- 07 Steel, zinc plated
 - 52 Stainless steel passivated

TL - 17 - 20 **B** - **F**

Keeper Style	Small	Narrow	Large	Medium
	TL-17-201-F	TL-17-202-F	TL-17-205-F	TL-17-209-F
Draw Latch	S Dimension			
TL-20-101	44.7 (1.76)	46.7 (1.84)	62.0 (2.44)	49.0 (1.93)
TL-20-102	30.3 (1.19)	32.3 (1.27)	47.6 (1.87)	34.6 (1.36)
TL-20-103	44.7 (1.76)	46.7 (1.84)	62.0 (2.44)	49.0 (1.93)
TL-20-106	33.9 (1.33)	35.9 (1.41)	51.2 (2.02)	38.2 (1.50)
TL-20-201	41.7 (1.64)	43.7 (1.72)	59.0 (2.32)	46.0 (1.81)
TL-20-202	28.2 (1.11)	30.2 (1.19)	45.5 (1.79)	32.5 (1.28)
TL-20-203	41.7 (1.64)	43.7 (1.72)	59.0 (2.32)	46.0 (1.81)
TL-40-101	30.7 (1.21)	32.7 (1.29)	48.0 (1.89)	35.0 (1.38)
TL-40-103	30.7 (1.21)	32.7 (1.29)	48.0 (1.89)	35.0 (1.38)
TL-40-201	43.7 (1.72)	45.7 (1.80)	61.0 (2.40)	48.0 (1.89)
TL-40-203	43.7 (1.72)	45.7 (1.80)	61.0 (2.40)	48.0 (1.89)

TL Draw Latch

Over-center · Wire bail



339

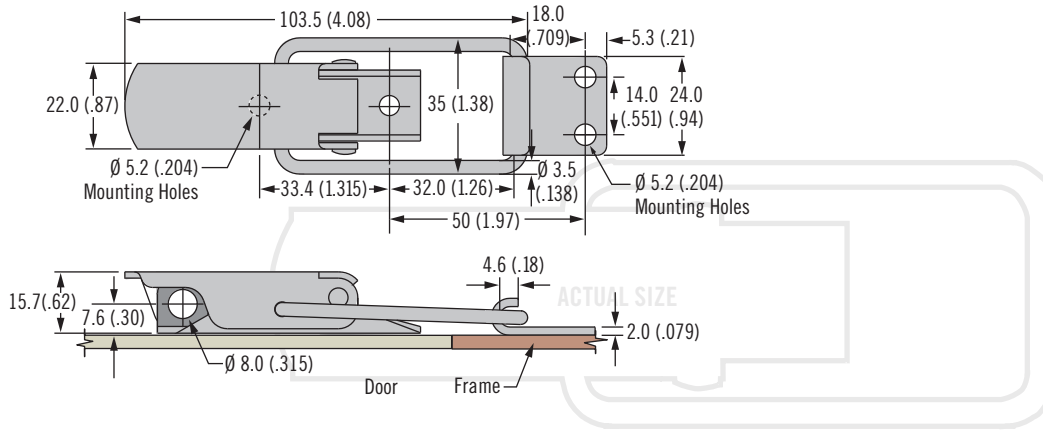

Description	Part Number	
	Steel	Stainless Steel
Latch	TL-50-201-07	TL-50-201-52
Keeper	TL-17-501-07	TL-17-501-52

- Robust construction
- Padlockable

Material and Finish

Stainless steel or steel, zinc plated

Performance Details

Working load: 2490 N (560 lbf)

Installation Notes

Install assembly with M5 (No. 10) round head screws (not supplied) or 5 (.196) rivets.

Part Number

See table

Order latch and keeper separately

TL Draw Latch

Over-center · Wire bail

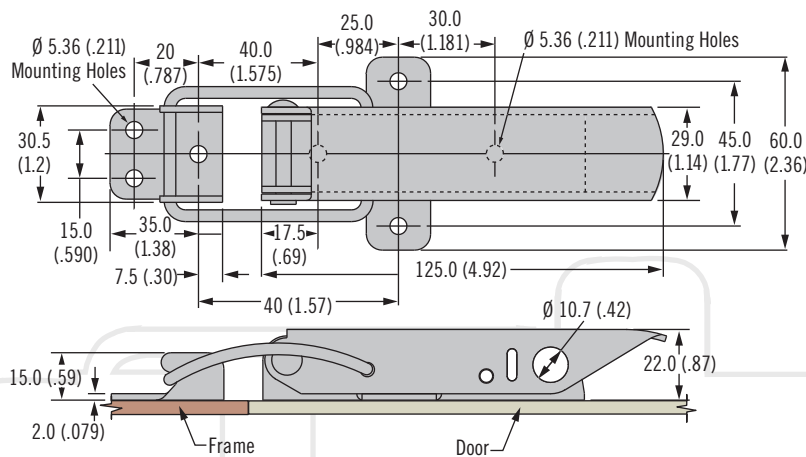

Description	Part Number
Draw Latch	TL-60-102-07
Keeper	TL-17-601-07

- Robust construction
- Padlockable

Material and Finish

Steel, zinc plated

Performance Details

Working load: 2670 N (600 lbf)

Installation Notes

Install assembly with M5 (No. 10) round head screws (not supplied) or 5 (.196) rivets

Part Number

See table

Order latch and keeper separately